

Installation Guide

Before you begin, take the time to read this entire guide to clearly understand the requirements and steps to follow for proper installation.

The Fastening Reference Line

Make shingle fastening simpler with this easily identifiable guide. The reference line is found 6 1/4" from the base of the shingle. For the 5" recommended shingle exposure, fasten just below the reference line to respect the installation requirement. Each individual shingle is marked on one side.

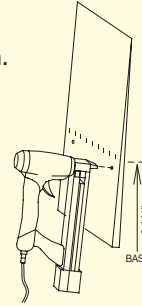

IMPORTANT: Compliance with maibec's installation, storage and maintenance requirements, and with building codes applicable in your region is mandatory. Problems caused by failure to comply with these requirements and codes may not be covered under applicable warranties.

For any questions, please contact maibec's technical service toll-free at 1-800-363-1930, Monday to Friday from 8:30 a.m. to 4:30 p.m.

Warning

The specifications in this guide apply to the installation of factory-stained white cedar shingles to exterior wall surfaces only. Do not install maibec shingles which appear to be, or you believe to be non-conforming. For more details, contact us.

Before you begin, consult your national, provincial and local building codes for requirements regarding the installation of shingle siding, breather membrane (housewrap), caulking, etc. Follow the manufacturer's instructions for installing the breather membrane and applying caulking.

For more information, consult the Government of Canada's *National Model Construction Codes* at <http://www.nationalcodes.nrc.gc.ca>.

For exterior use only.

Storage

- Store the shingle siding in a dry and ventilated area.
- Leave shingles boxes on pallet. Do not store the material in direct contact with the ground or a cement floor.
- Always cover the uninstalled material after a day's work.

1 Cutting Shingles

Since cedar is a soft wood, shingles can be easily cut with a utility knife. Cutting a shingle lengthwise is simple: make a straight cut into its surface, then snap the shingle cleanly along the scored line or use a power saw.

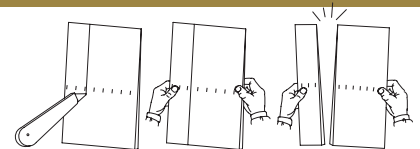

2 Touch-Up Stain

Apply touch-up stain on all cuts, planed edges, and small damaged areas. All bare wood must be touched-up, regardless of whether it is visible or not once installed. Touch-ups on cuts must be performed prior to shingle installation.

For shingle touch-ups, use the maibec touch-up applicator. For shingle touch-ups when using touch-up stain in a can, use a polyester, nylon, or any synthetic applicator with firm bristles approved for water-based coatings. Do not use wide brushes that could cause drips and give poor results. Carefully dab, do not spillover or overbrush.

Touch-up stain is only meant to be used in the area in need of it. It must not, under any circumstance, be applied over non-damaged factory-coated material.

For more information, see the touch-up guide that comes with the touch-up stain cans or kits, or go to www.maibec.com.

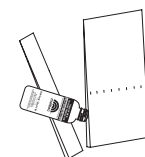

Shingle touch-up
APPLICATOR

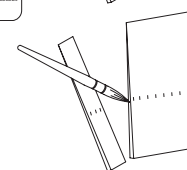

Touch-up
in a CAN

Important: Compliance with maibec's installation, storage and maintenance requirements, and with building codes applicable in your region is mandatory. Problems caused by failure to comply with these requirements and codes may not be covered under applicable warranties.

3 Determining Exposure

The exposure is the part of the shingle that you see. **The exposure for shingles is 5" (127 mm) but can vary between 1/8" to 1/4"** depending on the height of the wall and the window positions.

To determine the number of courses needed and the exposure, measure the height of the wall from its lowest point (above the foundations). The butt edge of the first course of shingles must extend at least 1" (25 mm) beyond the foundation, so add 1" (25 mm) to the height of the wall. To determine the number of courses, divide the height of the wall by the exposure (example: 5"). Then calculate back by dividing the height of the wall by the number of courses previously obtained (rounded off) to determine the exact exposure.

Use a wooden pole that is long enough to measure the exposure over several courses. A straight furring strip should do the job. Once marked, place the pole against the wall to check the alignment of the courses with the windows. If possible, the shingle courses should be aligned with window tops and bottoms, or the exposure should be at least 4" (102 mm) in these areas. The last course at the top of the wall should also have at least 4" (102 mm) of exposure. If not, recalculate to get enough exposure, then mark the pole once again. Using the pole, mark the exposure lines on the wall. Keep the pole as a reference while installing the shingles.

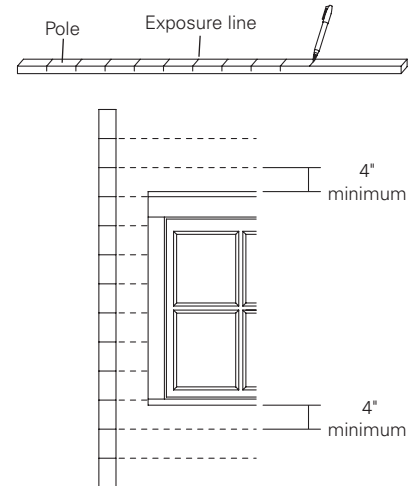

4 Fasteners

Nails:

- stainless steel or hot dipped galvanized
- ring shank blunt tip nail with minimum 7/32" (5.6 mm) head or

Staples:

- stainless steel or aluminum staple with minimum 7/16" (11.2 mm) crown, minimum 16 gauge.

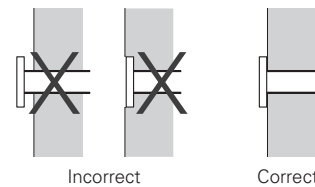

The fastening reference line is found 6 1/4" from the base of the shingle. For the 5" recommended shingle exposure, fasten just below the reference line to respect the installation requirement. Each individual shingle is marked on one side.

Two fasteners per shingle, regardless of its width.

Located 3/4" (19 mm) from each edge and 1" (25 mm) above the butt line of the overlapping shingle. Must penetrate solid nailable substrate minimum 1/2" (13 mm) (example: plywood).

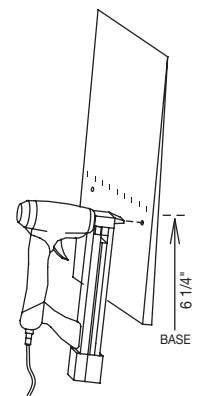

5 Exposure and Keyway Spacing

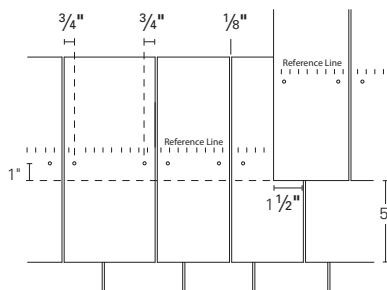

For walls, use a 5" (127 mm) exposure.

Leave a keyway space of at least 1/8" (3 mm) between shingles. The edges should not touch. The keyway spacings on consecutive rows must be offset a minimum 1 1/2" (38 mm).

Important: Compliance with maibec's installation, storage and maintenance requirements, and with building codes applicable in your region is mandatory. Problems caused by failure to comply with these requirements and codes may not be covered under applicable warranties.

6 The Starter Course

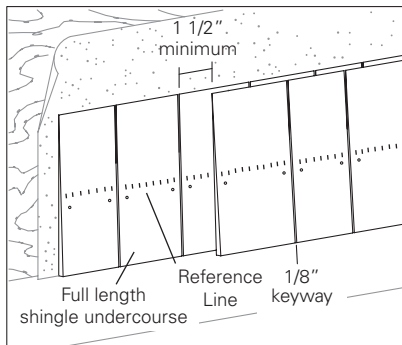

The starter course has two layers of shingles. The easiest method consists of installing 2 courses of full-length shingles one on top of the other, making sure that joints aren't aligned over subsequent courses.

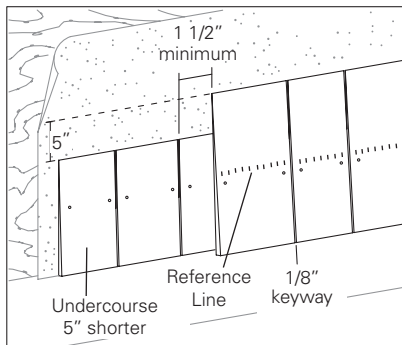

Another method consists of installing the first course using shingles trimmed 5" (127 mm) from the base, then continuing the second course with full-length shingles, making sure that joints aren't aligned over subsequent courses. With this method, all the courses will have the same thickness on the wall.

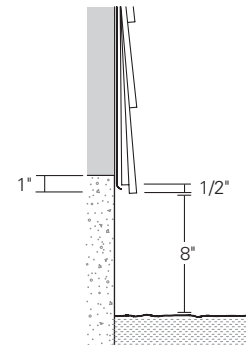

The starter course must extend at least 1" (25 mm) beyond the foundation to keep water off the wall. The second course extends slightly below (1/2" or 13 mm) the starter course to allow water to drip at the base of the shingles by gravity.

The butt line of the starter course must have a minimum clearance of 8" (203 mm) with the ground surrounding the building.

Allow a minimum clearance of:

- 1" (25 mm) from adjacent horizontal structures (example: deck),
- 2" (51 mm) from roof shingles or according to building code.

7 Subsequent Courses

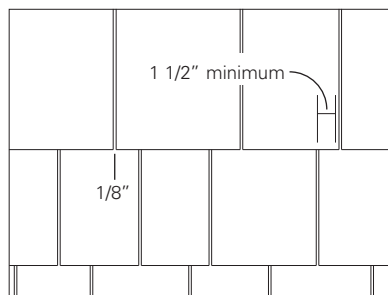

Shingles come in random widths, so you must make sure that the joints are not aligned over subsequent courses. Leave a keyway spacing of at least 1 1/2" (38 mm) from the shingles in the previous course. Ideally, no joints should be aligned over three subsequent courses. No joint should occur over a knot.

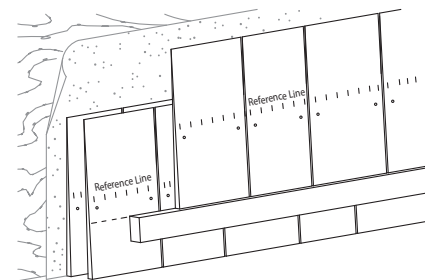

Install subsequent courses in a single layer on the rest of the wall according to the determined exposure. Keep your courses straight and level. To make shingle alignment easier, tack a furring strip beneath the exposure line or make a chalk line.

8 Corners Finish Details

The «Boston» Corner

The most common and traditional outside corner trim is made by overlapping shingles so that the joints alternate successively on each side of the corner. Nail the lower corner of the shingle with a ring shank blunt tip nail

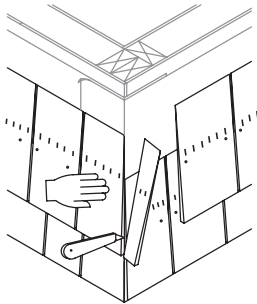

1. Choose a corner shingle that is wide enough to extend beyond the wall. Trim excess cleanly with a utility knife. You can trim it in place using the corner of the wall as a guideline, but for greater precision, you can mark a pencil line on the back of the shingle and cut it flat.

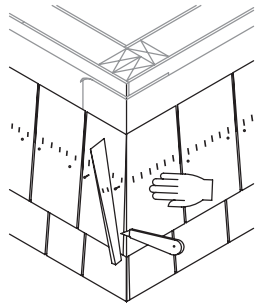

2. Tack the shingle in place while you install a second shingle that also extends beyond the wall on the other side. Trim the shingle, using the first shingle as a guideline. For a smooth finish, use a plane.

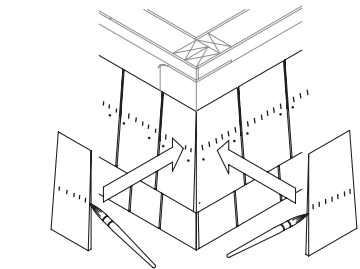
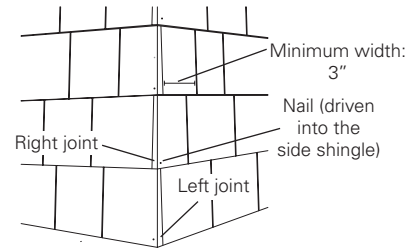

3. Apply touch-up stain to the cut edges, then nail the shingles in place according to the nailing recommendations.

maibec now offers a pre-assembled Woven Corner. See the maibec Woven Corner Installation Guide in TECHNICAL INFORMATION/Installation Guides.

9 Window Finish Details

Wood Cased Moulding

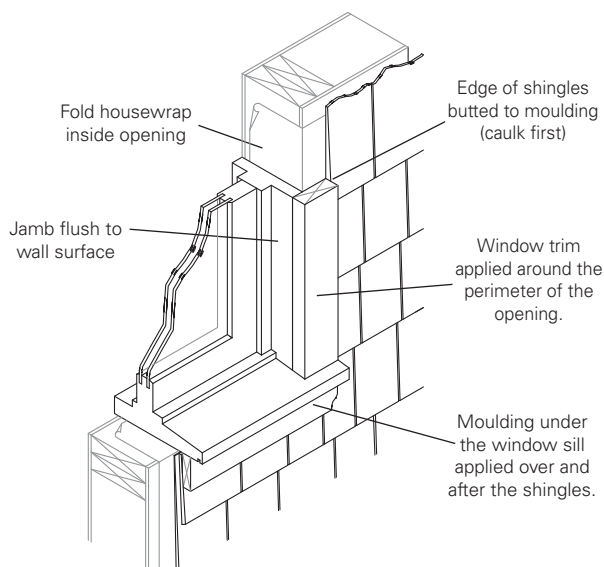

Perimeter Wood Moulding

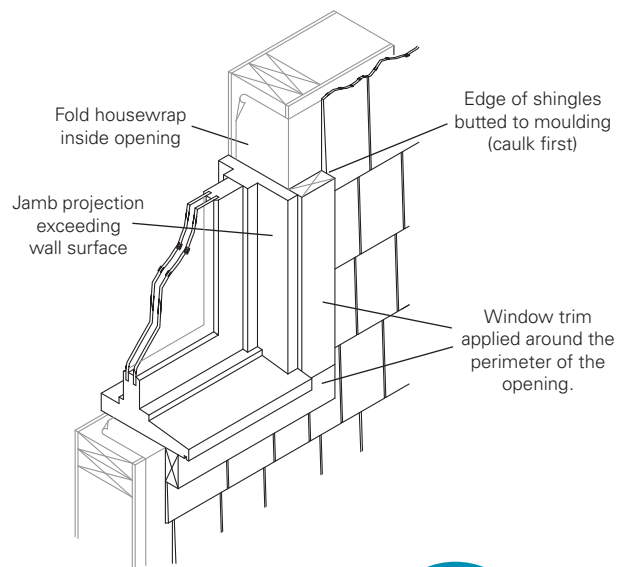

Important: Compliance with maibec's installation, storage and maintenance requirements, and with building codes applicable in your region is mandatory. Problems caused by failure to comply with these requirements and codes may not be covered under applicable warranties.

Window Finish Details (cont'd)

When a shingle is installed against the lower corner of the window opening, the joint must be aligned with the edge of the opening. For greater stability of shingles below openings, apply glue to the back and nail the bottom corners. Pre-drilling of the shingles may be required.

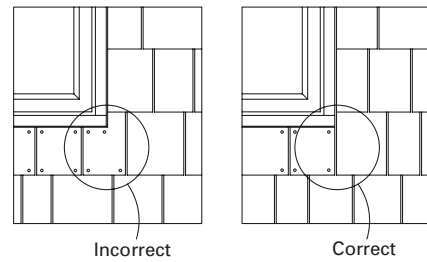

The Window Header

The window header is a crucial element where water could accumulate and seep behind shingles, which could affect the structural integrity of the window frame.

Metal flashing is essential to keep moisture away from the window header. The flashing should extend beyond the trim that will be installed.

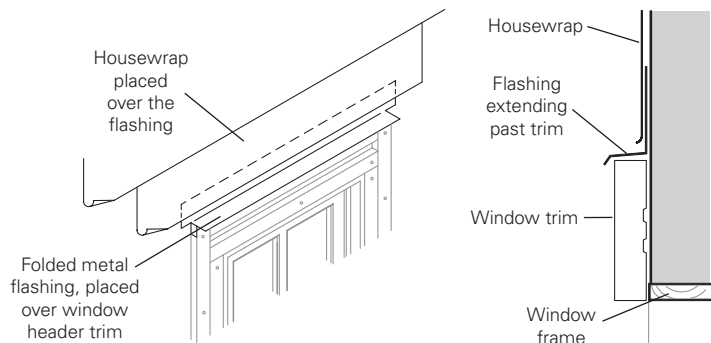

Shingles installed above window and door headers must be spaced 1/4" (6 mm) to 1/2" (13 mm) to ensure proper drainage and airflow.

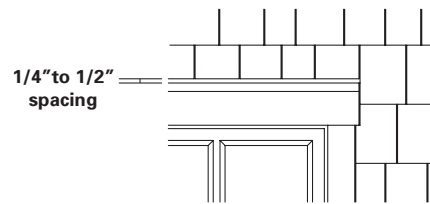

10 Top of the Wall Finish Details

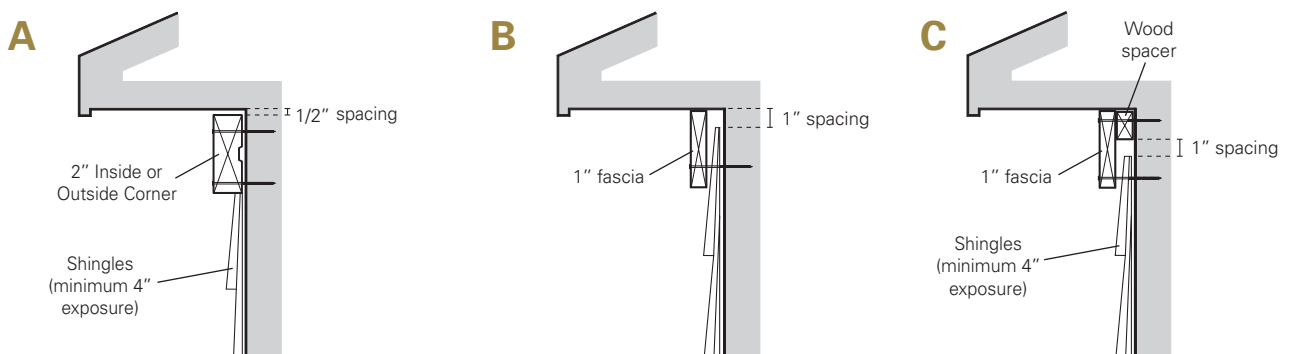

The typical way to finish the top of a wall is to install a moulding and have the shingles butt directly to it. This is traditionally done when the shingle course is wide enough, a minimum 4" (102 mm) long shingle is the norm for this type of application. To facilitate airflow at the top of the wall, it is important to leave a 1/2" (13 mm) gap between the moulding and the soffit.

Another way of finishing the top of a wall is to place a 1" fascia board over the installed shingles. This is typically called « capping ». A wood spacer is sometimes needed behind the fascia trim for a proper flush setting, as is the case with gables. To facilitate air flow behind the moulding in this application, it is important to leave a 1" (25 mm) gap between the last shingle and the wood spacer.

Important: Compliance with maibec's installation, storage and maintenance requirements, and with building codes applicable in your region is mandatory. Problems caused by failure to comply with these requirements and codes may not be covered under applicable warranties.

11

Gables

Finishing under sloping soffits such as gables calls for special attention because the remaining triangular shingles have visible nails. These shingles are often narrower and more fragile. You must glue the back, cover with a trim and sometimes nail the lower corner for greater stability and to keep them from curling. There are several ways this can be done.

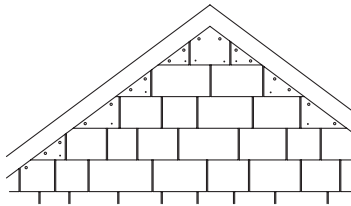

Cut the shingles at the end of the course on the same angle as the gable. This way the end shingles need fewer nails.

OR 10B (see previous page)

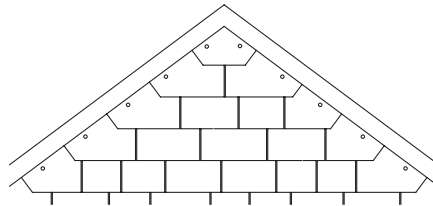

OR 10C (see previous page)

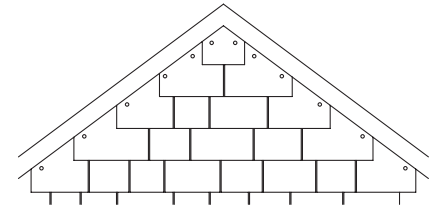

OR Leave the section open at the end of the course.

See the maibec Wides Installation Guide in TECHNICAL INFORMATION/ Installation Guides.

12

Dormer/Roof Junction Finish Details

The shingle must be spaced at least 2" (51 mm) when it ends adjacent to the roof surface (or according to the building code). The spacing is necessary to properly drain water and prevent the build-up of ice against the shingles siding.

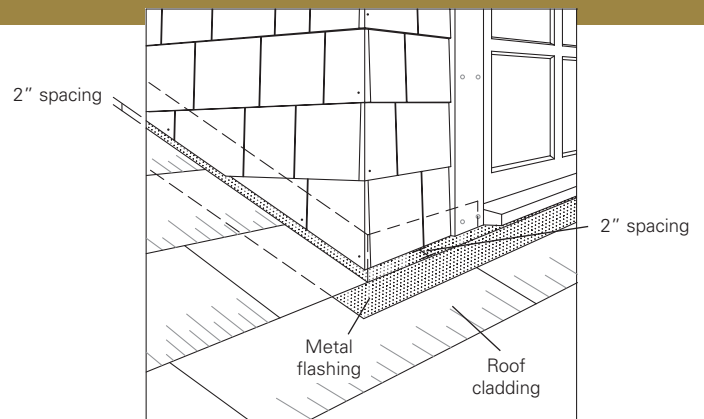

Maintenance

As with all sidings, dirt build-up can occur; this can be due to a number of factors such as surrounding vegetation, dust or air pollution. Periodic cleaning may be required. Clean the dirt off of the siding using a gentle water spray from a household low-pressure garden hose (under 100 psi). In rare instances where the dirt is not removed with a simple spray of water, you can gently scrub the surface using a soft brush and a non-abrasive laundry detergent, or a dishwasher detergent diluted as follows: 1/3 cup detergent for 3 litres of water. Because they produce suds, dish detergent are not recommended.

Rinse gently with a low-pressure garden hose (less than 100 psi). **Do not use a pressure washer.**

See the maibec Sidings Maintenance Guide for more details.

Important: Compliance with maibec's installation, storage and maintenance requirements, and with building codes applicable in your region is mandatory. Problems caused by failure to comply with these requirements and codes may not be covered under applicable warranties.

1 800 363-1930
maibec.com

202 – 1984, 5^e Rue, Lévis QC G6W 5M6 Canada

